

Development of a Low-cost Positioning System Using OEM GPS Receivers and Usability in Surveying Applications

Reha Metin ALKAN, TÜRKİYE

Key words: GPS, Low-cost GPS Receiver, OEM Type GPS Receiver.

SUMMARY

In this paper, a cost-effective positioning system which utilizes different low-cost Original Equipment Manufacturers (OEM) GPS Receivers, i.e. Garmin GPS25-HVS and Magellan Professional AC12, is introduced and examined for potential use in surveying applications. The developed positioning system is tested with several field measurements to assess the performance of the system for various baseline lengths (i.e. about 6 km, 29.2 km and 50.6 km) and occupation time (from 30 minutes to several hours) in static mode. The research and analysis carried out in this study showed that, centimetre-level positioning accuracy can be routinely achieved with such a low-cost system, which meets the requirements of a number of surveying and GIS applications. Results also showed that, using such a low-cost system would decrease the cost of surveying tasks; therefore, it can be regarded as a strong economical alternative to the geodetic-grade GPS receivers. This paper presents the study results of the developed low-cost positioning systems and tests procedures and their results.

Development of a Low-cost Positioning System Using OEM GPS Receivers and Usability in Surveying Applications

Reha Metin ALKAN, TÜRKİYE

1. INTRODUCTION

Global Positioning System (GPS) enables positioning with the accuracy from a few tens of meters down to a few centimetres. Ability of positioning regardless of day, night and weather conditions and advantages of high-quality positioning in almost all applications makes GPS more and more popular in civil and military applications. Positioning with GPS can be realized in two main ways i.e. single point positioning and differential positioning. Single Point Positioning (SPP) (or stand-alone) is taken into account when the GPS positioning is performed with an individual receiver only getting the signals from the satellites and nothing else. SPP is especially used mainly when a relatively low accuracy, like navigation, is required. To provide higher accuracy requirements, single or dual frequency geodetic-grade GPS receivers that measure carrier phase have to be used. The cost of single or geodetic-grade dual-frequency receivers are still expensive which are available at about USD 5,000 and USD 15,000 for single and dual-frequency units, respectively.

In recent years the positioning has started using OEM type low-cost GPS receivers/boards that can output carrier phase data as an alternative to the geodetic receivers. Such low-cost (single frequency) receivers are now available within a few hundreds of US dollars. Some experiments and obtained results with such a system in static and/or kinematic modes are reported in Masella *et al.* (1997), Rizos *et al.* (1998), Masella (1999), Abidin and Muchlas (2005), Söderholm (2005), Alkan *et al.* (2006), Saeki and Hori (2006), Alkan *et al.* (2007), Alkan *et al.* (2008), Alkan and Saka (2009), Schwieger (2009) and Wang *et al.* (2009).

The main purpose of this study is to examine the usability of a developed low-cost carrier-phase-based GPS positioning system in surveying applications. In this study two different types of OEM GPS receivers, i.e. Garmin GPS25-HVS and Magellan Professional AC12 GPS, are used. The performance of the developed positioning systems are tested with several field test measurements to assess the performance of the system in the Ayazaga Campus of Istanbul Technical University (ITU). This paper presents the study results on the developed low-cost positioning system and test procedures and their results.

2. DEVELOPED LOW-COST POSITIONING SYSTEM

In this study a cost-effective positioning system which utilises different types of OEM GPS receivers, i.e. Garmin GPS25-HVS and Magellan Professional AC12, has been developed. The developed system is introduced in the following sections.

2.1 Low-cost Positioning System Using Garmin GPS25-HVS Board

The main components of the developed positioning system using Garmin GPS25-HVS is illustrated in Figure 1.

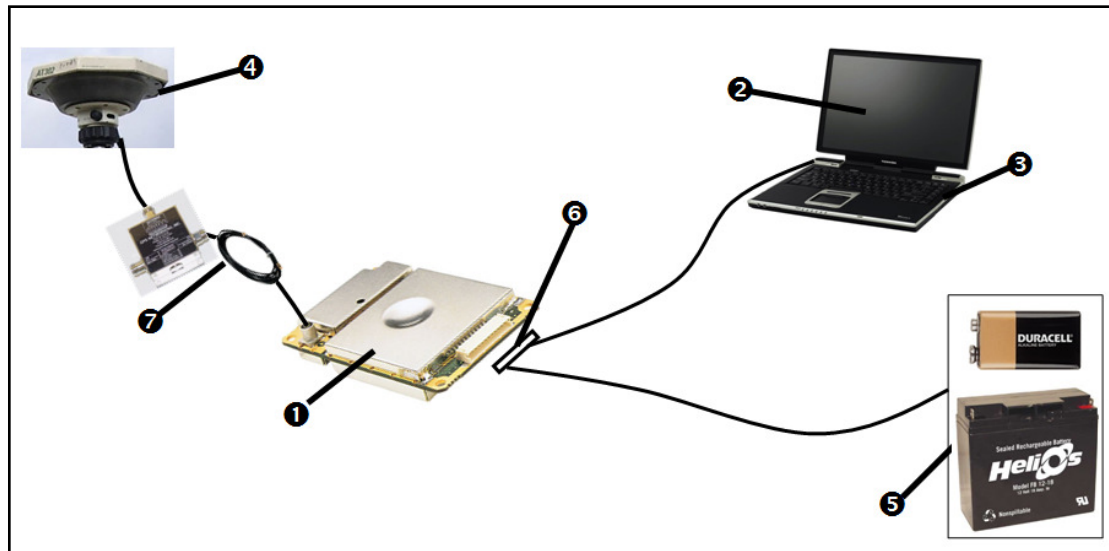

Figure 1. Low Cost OEM Type Positioning System Using Garmin GPS25-HVS

❶ GARMIN GPS25-HVS OEM Board: GPS25 has several features including a real-time clock, PPS timing output, non-volatile memory, differential GPS capability, and raw measurement output for both pseudorange and phase data, i.e. code and carrier phase on L1. This single frequency receiver has also differential-ready 12 parallel channel and tracks and uses satellites with a 1 Hz update rate. The size of the receiver is 46.5 mm x 69.9 mm x 11.4 mm and it weighs 38 g (URL 1). More details about its usage and specifications can be found in reference Garmin (2000).

❷ ❸ Data Acquisition Software and Laptop for Collecting Data: The GPS25 receiver can be connected to a datalogger (i.e. laptop) by the serial port because of the lack of memory. Therefore, a laptop in combination with data acquisition software is necessary to display and log raw data (both pseudorange and phase data) output by the GPS25 in real-time. For this purpose, a DOS-based Garmin own software is used (Figure 2). The program also performs uploading almanac, position, time information and downloading almanac and ephemeris information.

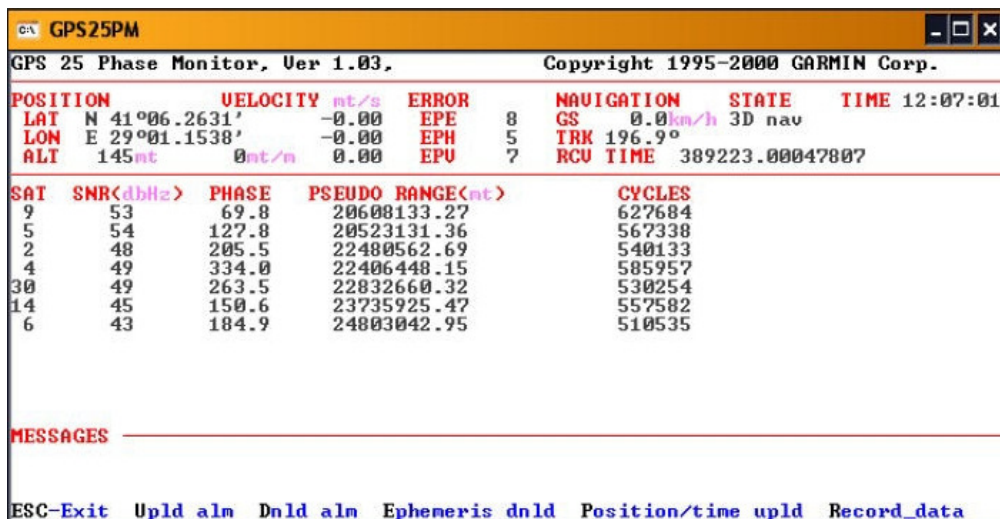

Figure 2. Raw Data Collection (Phase Data Output Displaying and Logging Screen)

The collected data in Garmin own format has to be converted to Receiver INdependent Exchange (RINEX) format in order to import and post-process them with different GPS post-processing software. To do that, a software named as GARRIN is coded. This software is running on a Windows based PC and converts the collected data into a RINEX observation file by entering marker name, observer and agency, session number and antenna (Figure 3).

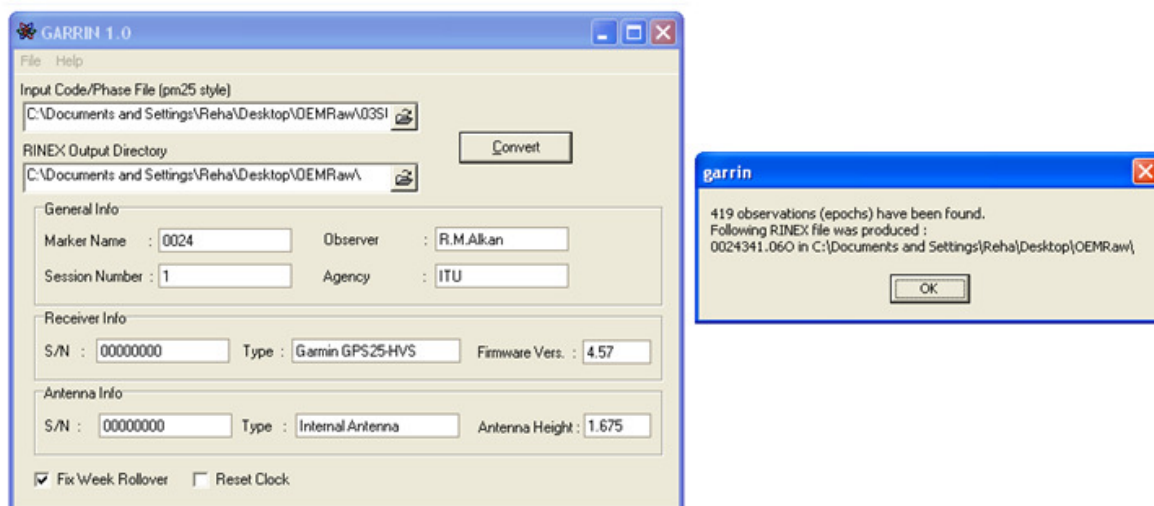

Figure 3. GARRIN RINEX Converter Software

④ Dual or Single Frequency Geodetic/Low-cost Antennas

⑤ Power Supply: Connection is established so as to allow the system work by various power options.

⑥ Power/Data Cable: There are two serial data output ports on the used board. One of them provides phase data output while the other one serial data which is formatted per NMEA

0183, Version 2.0 which is switchable between 300, 600, 1200, 2400, 4800, 9600 or 19200 baud rates.

⑦ Antenna&Various Adapter Cables and Antenna Splitter: System is designed so that the receiver collects data from both low cost and geodetic GPS antennas.

2.2 Low-cost Positioning System Using Magellan Professional AC12 GPS OEM Receiver

In this study, another OEM type GPS receiver, AC12 GPS OEM Receiver from Magellan Professional, is also used for the development of the positioning system (Figure 4).

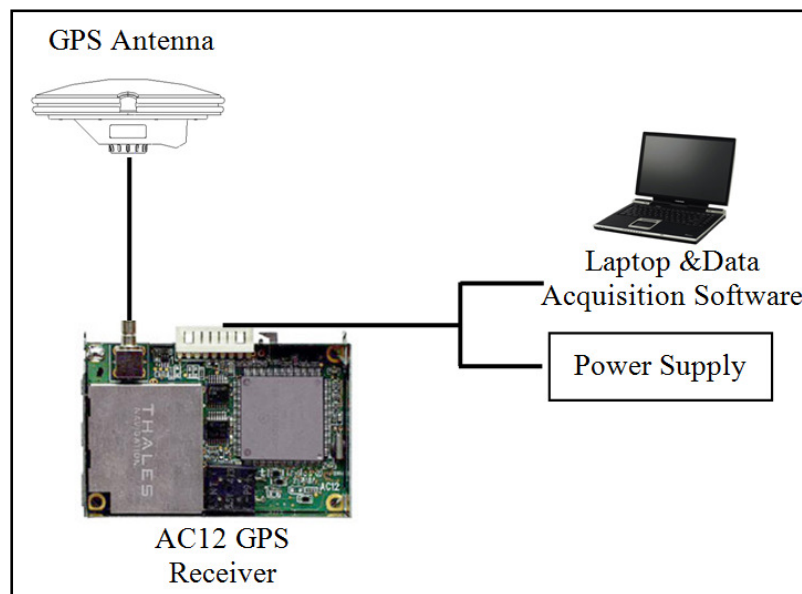

Figure 4. Low Cost OEM Type Positioning System Using AC12

Some important features that offered by AC12 are given as follows:

- 12-channel continuous tracking with 1 Hz update rate,
- Low power consumption (0.23 watts),
- User-defined and pre-defined datums,
- Two-way serial port communications,
- L1 frequency,
- Raw data output (code and carrier),
- Precise carrier-phase tracking (carrier phase measurement accuracy is 3 mm),
- 1PPS output accurate to better than 250 nanoseconds,

More details about the receiver can be found in Thales (2005).

In order to log raw data (both pseudorange and phase) with the AC12 receiver, a Windows-based software, Ashtech Evaluate, can be used (Figure 5).

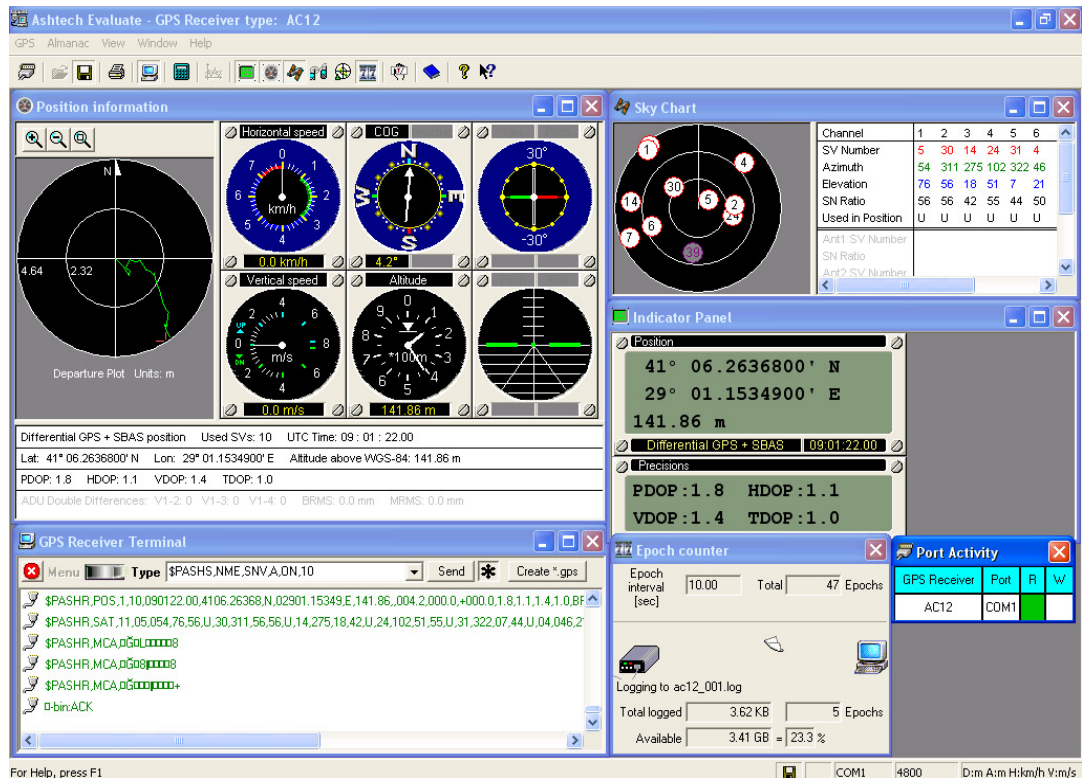

Figure 5. Data Display and Logging with Ashtech Evaluate Software

The Ashtech Evaluate software has several windows to show different information. For instance, 'Position Information' window provides real-time graphic display of basic GPS information like real-time accuracy, charts receiver position, graphically displays horizontal speed, vertical speed, altitude, tabular summary of Lat./Long., altitude above WGS-84, UTC time, DGPS status, number of SVs used in position calculation, and HDOP, VDOP, PDOP, TDOP. 'Sky Chart' window provides detailed information about the satellite constellation and displays relative satellite signal strength. The software has a simple terminal program (GPS Receiver Terminal window) that gives the option to open a terminal screen to communicate with the receiver by sending preset command strings, user-defined command strings, or individual set or query commands (Ashtech, 1997).

As a final stage, the collected GPS data in the receiver's own format is converted to the RINEX format by a DOS-based Thales software.

3. STATIC FIELD TRIAL

Three different static test measurements are conducted in the Ayazaga Campus of Istanbul Technical University in order to test the developed system's accuracy and performance as a function of occupation time and baseline lengths (Figure 6).

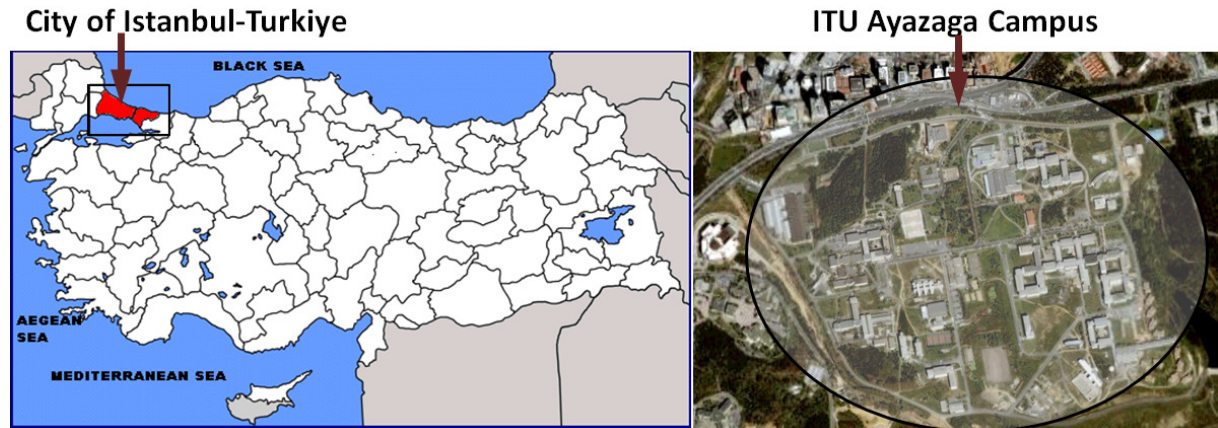

Figure 6. The Study Area (ITU Ayazaga Campus)

In the first trial measurement, the GARMIN GPS25 and Ashtech Z-Xtreme dual frequency geodetic-grade receivers are connected to a Ashtech's single-frequency geodetic GPS antenna via an antenna splitter. The system then is set up on a point (Campus Point 1 - CP 1) located on the roof of our faculty building and data were collected at 1 second interval. In the other trials, AC12 OEM GPS receiver together with Ashtech Z-Xtreme dual frequency geodetic receiver are connected to Ashtech dual frequency GPS antenna via an antenna splitter and data are collected at 10 second interval on the same point (Figure 7). In this way, GPS data with OEM are collected possibly under the same conditions with the geodetic receiver. This allows precise accuracy assessment of the low cost system by comparing their results with geodetic ones. The coordinates of the roof point are determined using geodetic-grade GPS receivers with respect to IGS and/or continuously operating GPS reference stations TUBI ($40^{\circ}.7867$ N, $29^{\circ}.4507$ E WGS84), BAD1 ($40^{\circ}.8521$ N, $29^{\circ}.1179$ E WGS84) and KANDILLI-KANT ($41^{\circ}.0608$ N, $29^{\circ}.0614$ E WGS84). These points are also used as reference stations through the trial measurements.

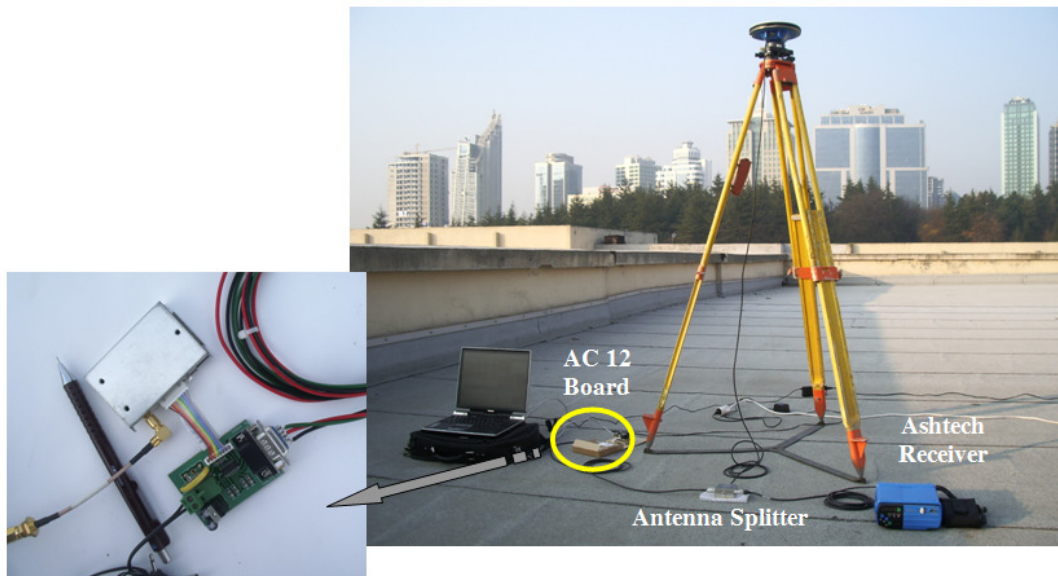

Figure 7. Surveying with OEM type and Geodetic-grade GPS Receivers

Some information about the trial measurements are summarized in Table 1.

Table 1. Trial Measurements Summary

Trial Number & Date	Reference Station-Marker Name	Rover Station Name	Baseline Length (km)	Occupation Time (minutes)	Rover Receivers/ Antenna Type
Trial-1 November 25, 2006	- TUBI - KANDILLI (KANT)	CP-1	~ 50.6 ~ 6.0	30, 60 (2 parts) and 120	Garmin GPS25& Ashtech Z-Xtreme / L1 Geodetic Antenna
Trial-2 December 07, 2006	- TUBI - BAD1 - KANDILLI (KANT)	CP-1	~ 50.6 ~ 29.2 ~ 6.0	30, 60 and 120	Magellan AC12 OEM&Ashtech Z-Xtreme / L1&L2 Geodetic Antenna
Trial-3 December 08, 2006	- TUBI - BAD1 - KANDILLI (KANT)	CP-1	~ 50.6 ~ 29.2 ~ 6.0	30 (2 parts), 60 and 120	

4. EVALUATION OF THE COLLECTED DATA

All the collected data are converted to the RINEX format with the software described in the Section 2 and then imported to Leica Geo Office (LGO) v. 6.0 commercial software for processing. The coordinates of the rover antenna connected to the OEM and geodetic receivers are estimated using baselines referenced to the 'Reference Stations' with LGO

software. All of the baselines given in Table 1 are processed. The processing parameters used in the software are given in Table 2.

Table 2. Some Processing Parameters Used in the LGO Software

Elevation Angle	: 10^0
Ephemeris	: Precise IGS Orbits
Tropospheric Model	: Saastamoinen
Ionospheric Model	: Computed

The coordinates of the Garmin OEM receiver are estimated with only float ambiguity solution whereas all phase ambiguities are resolved successfully for AC 12 and geodetic-grade receivers. The main reason of the float solutions can be explained that the initial ambiguity parameters will not, in general, be integer numbers. Instead they will be, in general, multiples of half cycles (Alkan *et al.* 2006).

Final coordinates obtained with LGO baseline solutions are compared with their known values. Differences in latitude, longitude and ellipsoidal height components are shown in Figure 8.a, b and c for the Trial 1, 2 and 3, respectively.

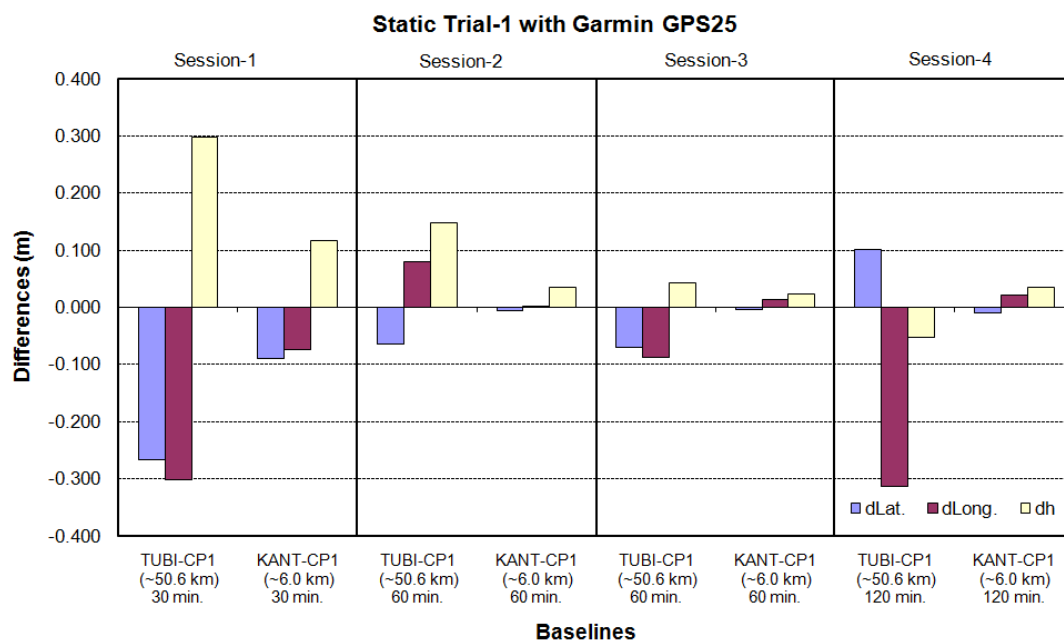

(a)

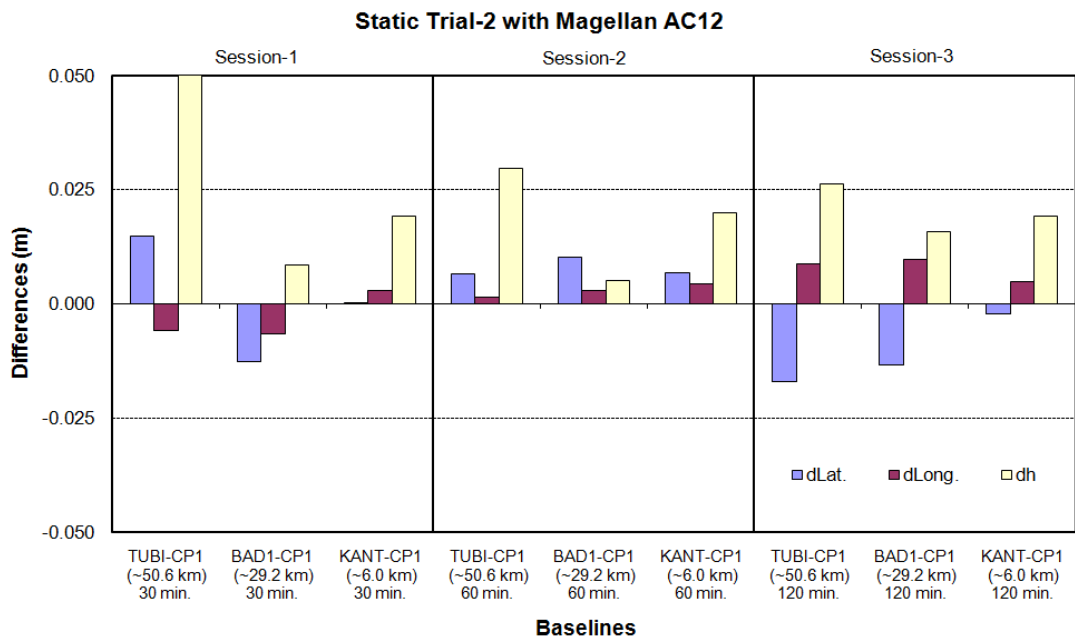

(b)

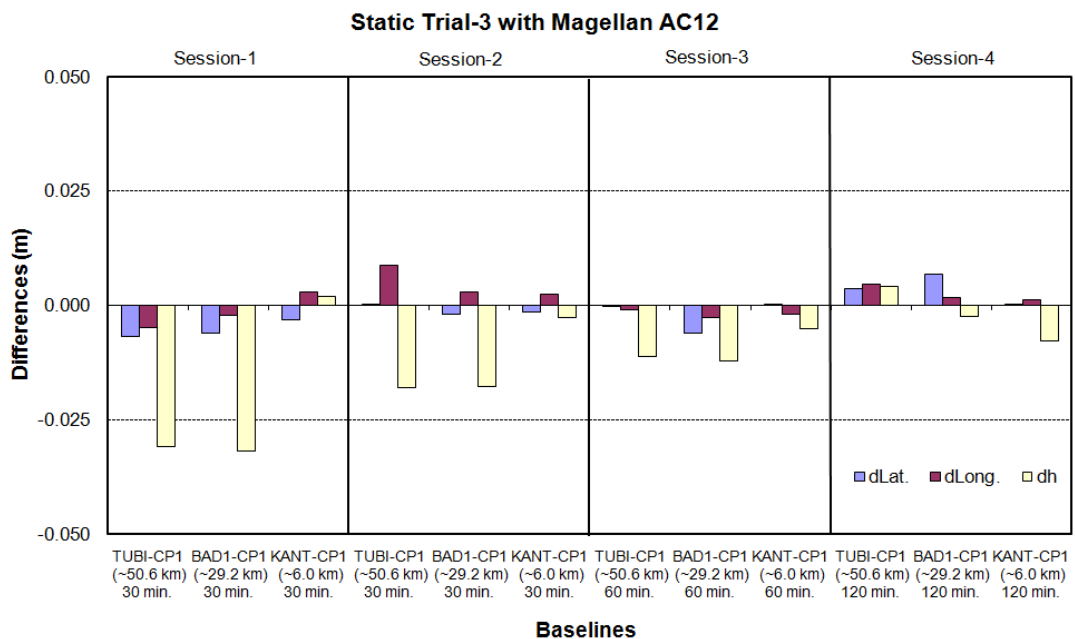

(c)

**Figure 8. Differences between OEM-derived and Known Coordinates
(a) for Trial-1, (b) for Trial-2, (c) for Trial-3**

The results obtained from the Garmin GPS25 receiver showed that position accuracy at a few centimetre-level is possible for the short baselines (i.e. 6.0 km) when the occupation time of 60 minutes or more is used (Figure 8.a). In contrast, the results for the 51 km baseline are relatively poor, i.e. a few decimetre-level, even for 2 hours occupation time is used. The results for the height component is similar to position component.

On the other hand, the coordinates estimated by the AC12 receiver agree with the known coordinates with a difference of a few centimetres for both short and long baselines (i.e. 6.0 km, 29.2 km and 50.6 km) even with a shorter occupation time (30 minutes) both in position and height components (Figure 8.b and c).

5. CONCLUSIONS

In this study, a cost-effective positioning system which uses OEM GPS receiver that can output carrier phase data is introduced and the usability of such a system in surveying applications is investigated. In order to assess the performance of the system in static mode, several field trials are conducted. The research and analysis carried out in this study showed that, a few centimetre positioning accuracy can be routinely achieved for especially Magellan AC 12 GPS receiver with a commercial software. Similar to the AC 12, the accuracy of the Garmin GPS25 receiver-derived coordinates can be obtained with a few centimetre-level positioning accuracy especially for short baselines. It is clear that such a level of accuracies obtained from both AC12 and GPS25 receivers provide the requirements of a number of surveying and GIS applications. Results also showed that using such a low-cost system would decrease the cost of surveying tasks; therefore, it can be regarded as a strong economical alternative to the geodetic type GPS receivers.

ACKNOWLEDGEMENTS

The authors would like to thank TUBITAK Marmara Research Center and Bogazici University, for supplying the BAD1 and KANDILLI-KANT GPS data.

REFERENCES

- Abidin, H.Z., Muchlas, A. (2005). GPS Surveying Using Navigation Type Receivers. *In: Proc. of the South East Asia Survey Congress 2005*, 21-25 November, Bandar Seri Begawan, Brunei Darussalam.
- Alkan, R.M., El-Rabbany, A. and Saka, M.H. (2006). Assessment of Low-Cost Garmin OEM GPS Receiver for Surveying Applications, *Ontario Professional Surveyor*, 49(4), pp. 14-16.
- Alkan, R.M., El-Rabbany, A. and Saka, M.H. (2007). Low Cost Single-Frequency GPS for Surveying: A Performance Analysis, *Location*, 2(2), pp. 28-31.
- Alkan, R.M., Saka, M.H., Kalkan, Y., Şahin. M. (2008). Usability of Low-Cost L1 Frequency GPS Receivers in Surveying Applications, *In Proceedings of the Toulouse Space Show'08, European Navigation Conference (ENC-GNSS)*, Toulouse, France.
- Alkan, R.M. and Saka, M. H. (2009). A Performance Analysis of Low-Cost GPS Receivers in Kinematic Applications, *Journal of Navigation*, 62 (4), 687–697.
- Ashtech (1997). Ashtech Evaluate 5.0 User's Guide, Sunnyvale, CA USA.
- Garmin, (2000). GPS25 LP Series GPS Sensor Boards Technical Specification, Rev. G. Mar, p.42, Kansas.
- Masella, E., Gonthier, M. and Dumaine, M. (1997). The RT-Star: Features and Performance of a Low-Cost RTK OEM Sensor, *In Proc. of the ION GPS'97, The International Technical Meeting of the Satellite Division of the ION*, pp. 53-59, Kansas City, Missouri.
- Masella, E. (1999). Achieving 20 cm Positioning Accuracy in Real Time Using GPS-The Global Positioning System, *GEC Review*, 14(1), pp. 20-27.
- Rizos, C., Han, S. and Han, X. (1998). Performance Analysis of a Single-Frequency, Low-Cost GPS Surveying System, *In Proc. of the 11th Int. Tech. Meeting of the Satellite Division of the US ION, GPS ION'98*, pp. 427-435, Nashville, Tennessee.
- Saeki, M., Hori, M. (2006). Development of an Accurate Positioning System Using Low-Cost L1 GPS Receivers, *Computer-Aided Civil and Infrastructure Engineering*, 21(4), pp. 258-267.
- Schwieger, V. (2009). Accurate High-Sensitivity GPS for Short Baselines. *In Proc. of FIG Working Week 2009*, Eilat, Israel.
- Söderholm, S. (2005). GPS L1 Carrier Phase Double Difference Solution Using Low Cost Receivers, *In Proc. of ION GNSS 18th International Technical Meeting of the Satellite Division*, pp.376-380, Long Beach, CA.

Thales (2005). A12, B12 & AC12 Reference Manual, p.176, USA.

Wang, C., Shao, Y., Dai, L., Eslinger, D. (2009). A Low-cost Precise Navigation Solution using Single-frequency GPS Receiver, In *Proc. of the ION 2009, International Technical Meeting*, pp. 673-681, Anaheim, CA.

URL 1, GARMIN Web Page, GPS 25 Series,
<https://buy.garmin.com/shop/shop.do?CID=170&pID=70>, January 20, 2010.

BIOGRAPHICAL NOTES

Reha Metin ALKAN is currently working at Istanbul Technical University, Istanbul, Turkey as an Associate Professor. He holds MSc and PhD degrees in Geodesy and Photogrammetry Engineering Department from the same university. His research area mainly covers GPS and its applications, Hydrographic Surveying, Deformation Measurements and Analysis, Operational Research.

CONTACT

Assoc. Prof. Dr. Reha Metin ALKAN

Istanbul Technical University (ITU)
Faculty of Civil Engineering
Geomatics Engineering Department
Maslak, TR-34469,
Istanbul, TURKIYE

Telephone : +90 212 285 6564
Fax : +90 212 285 6587
E-mail : alkanr@itu.edu.tr